

# Development of “virtual patient” model for simulation of solute and fluid transport during dialysis

M. GAŁACH\* and A. WERYŃSKI

Institute of Biocybernetics and Biomedical Engineering, Polish Academy of Science 4 Ks. Trojdena Str., 02-109 Warsaw, Poland

**Abstract.** Optimization of dialysis needs methods for quantitative assessment of fluid and solutes transport in body compartments and solute and fluid exchange between body and dialysate. A mathematical model describing the dynamics of these quantities during dialysis is presented. This model is first and foremost based on the existing models, but also includes some new solutions. All parts were combined and extended by the detailed descriptions of selected aspects. The “virtual patient” model was applied to simulate and test different methods of treatment and their influence on the condition of the patient. The purpose of this model is to serve as a decision support system for selection of “optimal” treatment options for particular patient.

**Key words:** mathematical model, dialysis, transport phenomena.

## 1. Introduction

The mathematical models of the physiological systems are of paramount importance, because they can be used to improve our understanding of the behaviour of these complex systems. Important parts of them are models describing functions of the kidney or renal replacement therapies.

Kidneys perform many functions. Healthy kidneys purify blood by removing excess fluid, minerals, metabolic waste products and toxins, help control blood pressure by releasing enzyme renin, participate in making red blood cells and help maintain the proper balance of acid-base and minerals. When kidneys fail, one of the renal replacement therapies can be a life-saving solution. The main type of this therapy, beside kidney transplantation, is dialysis. Dialysis removes excess of water and small molecular waste products of metabolism across a semipermeable membrane. Two main types of dialysis are: hemodialysis and peritoneal dialysis.

Hemodialysis is the most common method used for treatment of end stage renal failure. Hemodialysis removes waste products, toxins and excess of fluid from the blood in an extracorporeal circuit in which the patient’s blood is pumped to a purification system called dialyzer (Fig. 1). The dialyzer has two spaces separated by a membrane: one for blood and another one for dialysis fluid (a solution, which is intended to exchange solutes and fluid with blood during hemodialysis). Toxins and other excess substances move across the membrane from the blood into the dialysis fluid due to the concentration gradient (diffusion) and due to fluid flow carrying solutes (convection). Excess of fluid is removed due to the pressure (mainly hydrostatic) difference between blood and dialysate (ultrafiltration). The purified blood through tubes returns to the bloodstream.

During peritoneal dialysis the blood is purified inside the body, solutes and water are transported across the peritoneum.

Peritoneum is a thin “membrane” that lines the abdominal and pelvic cavities, and covers most abdominal viscera. There are two types of peritoneum: parietal peritoneum that lines the abdominal and pelvic cavities and visceral peritoneum that covers the external surfaces of most abdominal organs. Both types of peritoneum take part in peritoneal dialysis [1]. Dialysis fluid containing an osmotic agent, most frequently glucose, is infused into the peritoneal space, through a catheter, and remains for a period of time (usually 4–6 hours in continuous ambulatory peritoneal dialysis, CAPD). The peritoneum allows waste products of metabolism to pass from the blood into the dialysate (in the processes of diffusion and convection), and then dialysate is drained out (Fig. 2). Because osmotic agent creates high osmotic pressure in dialysis fluid exceeding substantially osmotic pressure in blood, water (and small solutes) is transported from blood removing excess of fluid.

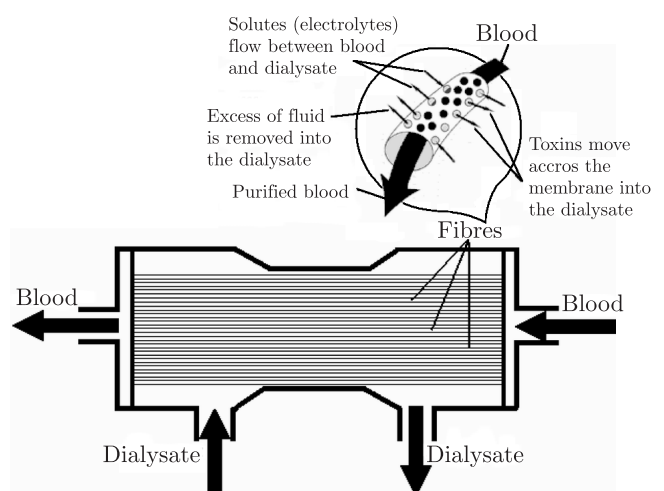

Fig. 1. Hemodialysis – blood purification in the dialyzer

\*e-mail: magda@ibib.waw.pl

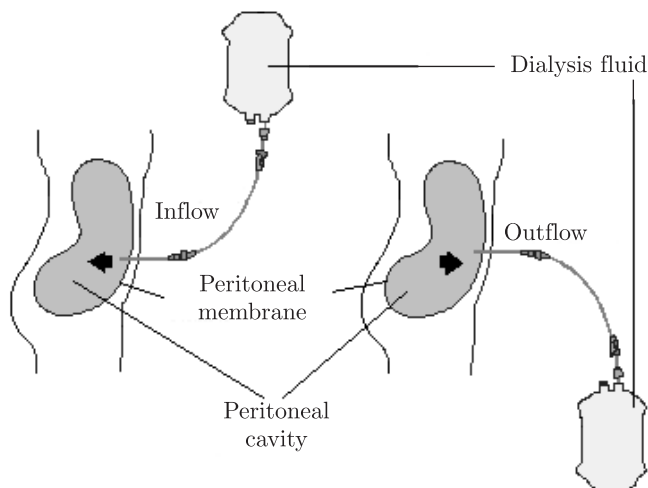

Fig. 2. A scheme of peritoneal dialysis

The model analyzed in this paper is first of all based on the partial models described mainly in [2–5] and is the most complete model of renal replacement therapies known to the authors. The model is composed of four parts. The first part deals with a fluid transport and kinetics of small solutes in the main compartments of the body. During hemodialysis, the blood volume decreases; therefore, the second part of the model describes the cardiovascular system. Additionally the control mechanisms which cause the compensatory reaction to blood volume loss are taken into account. The third part of model describes glucose-insulin interaction, and fourth part deals with description of dialysis (hemodialysis and peritoneal dialysis) treatments.

The main objectives of the model are: to serve, in the future, as a decision support system in selection of “optimal” treatment options for selected patients, to help in teaching and to contribute to a better understanding of important processes, which take place in the patient during renal replacement therapies. Additionally, “virtual patient” model would allow to partly replace “in vivo” experiments with animals with new or modified therapies by “in silico” experiments with the computer.

## 2. Model

A detailed description of different parts of the model and values of the parameters as well as detailed description of “virtual patient” model are presented in [2–7]. Because every mathematical model is a simplification of reality, the model cannot describe all details occurred in described processes. In “virtual patient” model, all simplification assumed in partial models [2–7] were adopted.

The presented model consists of above 50 ordinary differential equations and about 200 algebraic equations and, unfortunately, there is no place in this paper to describe all these equations. Also, for this reason the values of the parameters (which are over 300) were omitted. In this paper only a general description and simulation results are presented. The scheme of the “virtual patient” model is presented in Fig. 3.

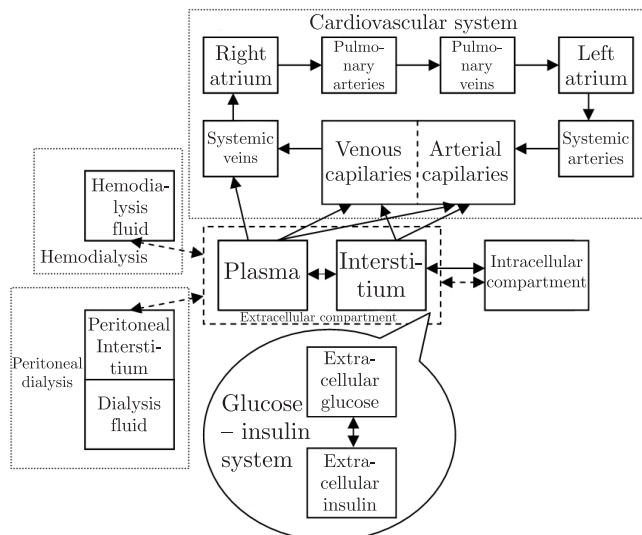

Fig. 3. Scheme of the “virtual patient” model – relationships between various part of the model; —> connection between different compartments, - -> connection between extracellular and same other compartments

**2.1. Fluid and solute transport.** Fluid transport is described using a three-compartmental model of the exchange of the fluids (Fig. 4a) between the intracellular fluid, the interstitial fluid and blood plasma.

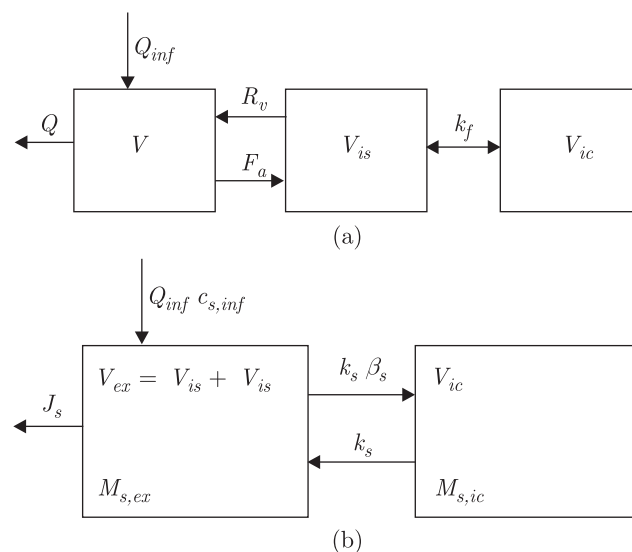

Fig. 4. The compartmental model used for the description of body fluids exchange (a) and solute kinetics (b);  $V$  – blood volume,  $V_c$  – fluid volume in compartment  $c$  ( $c = 'is'$  – interstitium,  $'ic'$  – intracellular compartment,  $'ex'$  – extracellular compartment,  $'pl'$  – plasma),  $M_{s,c}$  – concentration of solute  $s$  in compartment  $c$ ,  $C_{s,inf}$  – concentration of solute  $s$  in the replacement fluid,  $Q$  – fluid flow rate caused by renal replacement treatment (hemodialysis or peritoneal dialysis),  $Q_{inf}$  – infusion rate of fluid,  $R_v$  – venous reabsorption rate,  $F_a$  – arterial filtration rate,  $k_f$  – water exchange coefficient between the intra- and extracellular compartments,  $J_s$  – solute transport caused by renal replacement treatment,  $k_s$  – mass transfer coefficient between intra- and extracellular compartments for solute  $s$ ,  $\beta_s$  – coefficient describing which kind of the solute  $s$  transport exists (active or passive)

Development of “virtual patient” model for simulation of solute and fluid transport during dialysis

During dialysis, the total blood volume ( $V$ ) changes because of the fluid ultrafiltration flow across the hemodialyzer membrane or across peritoneal tissue to dialysate ( $Q$  – fluid flow rate during dialysis), possible fluid infusion ( $Q_{inf}$  – fluid infusion rate), filtration at the arterial capillaries ( $F_a$  – filtration rate), reabsorption at the venous capillaries ( $R_v$  – reabsorption rate), residual kidney excretion ( $J_k$  – excretion rate), and delivery of the fluid – i.e. drinking – ( $J_d$  – rate of delivery of the fluid). Fluid exchange between the intracellular and extracellular compartments depends upon the osmotic pressure difference ( $V_{ic}$  – volume of intracellular fluid,  $k_f$  – water transport coefficient between the intra- and extracellular compartments,  $c_{ic}$ ,  $c_{is}$  – concentration of all osmotically effective solutes in the intracellular or interstitial fluids). Hence [2]:

$$\frac{dV}{dt} = -F_a + R_v - Q + Q_{inf} - J_k + J_d, \quad (1)$$

$$\frac{dV_{ic}}{dt} = -k_f(c_{is} - c_{ic}), \quad (2)$$

$$\frac{dV_{is}}{dt} = k_f(c_{is} - c_{ic}) + F_a - R_v. \quad (3)$$

The transport of solutes is governed by the two-compartment description (the intracellular fluid and the extracellular fluid) based on the assumption that the concentrations of small solutes in the blood plasma and in the interstitial fluid are approximately equal (Fig. 4b). In the model it is assumed that the total blood volume ( $V$ ) is sum of the plasma volume ( $V_{pl}$ ) and the red cell volume ( $V_{rc}$ ), therefore:

$$V_{pl} = V - V_{rc}, \quad (4)$$

$$V_{ex} = V_{pl} + V_{is}, \quad (5)$$

where  $V_{ex}$  denotes extracellular fluid volume.

In the model, following substances were taken into account: potassium, sodium, urea, bicarbonate, chloride, glucose and insulin. However equations describing glucose-insulin system will be shown individually in the next section. In modelling peritoneal dialysis additionally eight fractions of icodextrin were analyzed (icodextrin is a mixture of polyglucose molecules with an average molecular weight 16 800 D and is newly introduced osmotic agent in peritoneal dialysis).

Substances can move into and out of cells across the cell membrane which is selectively permeable (allows selective movement of substances). There are two kinds of movement across the cell membrane: passive or active transport. Passive transport includes diffusion: molecules tend to move from an area (compartment) of high concentration to an area of low concentration in order to achieve a balance or to reach homeostasis. Active transport takes place when solute is transported up to its concentration gradient (from lower to higher concentration). This kind of transport involves the use of proteins that require the use of cellular energy (usually ATP).

Therefore, the solute flow rate depends on the concentration gradient and on the mass transfer coefficients  $k_s$  and  $\beta_s$  [2].  $\beta_s$  describes which kind of the solute transport exists:  $\beta_s = 1$  when the solute does not exhibit active transport (i.e. urea),  $\beta_s \neq 1$  when the solute is actively transported. Chloride

has a special task in the model: the description of the chloride exchange across the cellular membrane is based on the assumption that the net flow of the charge is always equal to 0 [3]:

$$\frac{dM_{s,ic}}{dt} = -k_s(c_{s,ic} - \beta_s c_{s,ex}), \quad (6)$$

$$\frac{dM_{Cl,ic}}{dt} = \frac{dM_{K,ic}}{dt} + \frac{dM_{Na,ic}}{dt} - \frac{dM_{HCO_3,ic}}{dt}, \quad (7)$$

$$\begin{aligned} \frac{dM_{s,ex}}{dt} = & -\frac{dM_{s,ic}}{dt} - J_{s,t} + Q_{inf}c_{s,inf} \\ & + G_{s,ex} - D_{s,k}c_{s,ex}, \end{aligned} \quad (8)$$

where:  $M_{s,i}$  – mass of solute  $s$  in compartment  $i$  ( $i = ic, ex, s = K^+, Na^+, U, HCO_3^-$  or  $Cl^-$ ),  $c_{s,i}$  – concentration of solute  $s$  in compartment  $i$ ,  $c_{s,inf}$  – concentration of solute  $s$  in infusion fluid,  $J_{s,t}$  – total solute flow rate during renal replacement therapy:  $t = 'hd'$  in the case of hemodialysis or  $t = 'pd'$  in the case of peritoneal dialysis,  $G_{s,ex}$  – generation rate of solute  $s$  in the patient body,  $D_{s,k}$  – residual renal clearance.

**2.2. Cardiovascular system.** A simplified description of the heart and of the cardiovascular system has been included in the model. The cardiovascular system is described as a set of six compartments (Fig. 5).

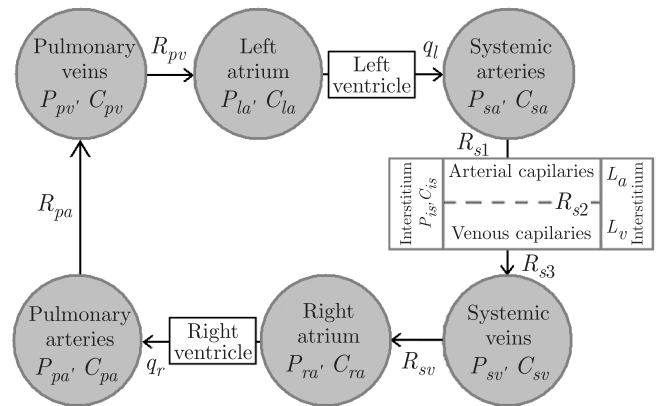

Fig. 5. The compartmental model used for the description of cardiovascular system ( $pv$  (pulmonary veins),  $la$  – left atrium,  $sa$  – systemic arteries,  $pa$  – pulmonary arteries,  $ra$  – right atrium,  $sv$  – systemic veins,  $is$  – interstitium),  $P$  – pressure,  $R$  – resistance,  $C$  – compliance,  $q_l$  and  $q_r$  – cardiac outputs from the left and right ventricles,  $L_a$  and  $L_v$  – the permeability coefficients at the arterial and venular capillary walls,  $R_{s1}$  – resistance upstream of the arterial capillaries,  $R_{s2}$  – resistance at the point of capillary circulation,  $R_{s3}$  – resistance downstream of the venular capillaries

A change of the pressure in each compartment depends on the compliance of the compartment ( $C_c$ ), pressures in neighbouring compartments (or cardiac output ( $q_l$ ,  $q_r$ ) and resistances ( $R_c$ ) [2], i.e.:

$$\frac{dp_{sa}}{dt} = -\frac{1}{C_{sa}} \left( q_l - \frac{p_{sa} - p_{ac}}{R_{s1}} \right), \quad (9)$$

$$\frac{dp_{pv}}{dt} = \frac{1}{C_{pv}} \left( \frac{p_{pa} - p_{pv}}{R_{pa}} - \frac{p_{pv} - p_{la}}{R_{pv}} \right). \quad (10)$$

Blood vessels are elastic and therefore there is a relationship between hydraulic pressure and filling volume in these vessels. In the model it is assumed that this relationship is linear, thus:

$$V_c = V_{uc} + C_c p_c, \quad (11)$$

where  $V_c$  is the total blood volume in the compartment  $c$  ('sa' – systemic arteries, 'pa' – pulmonary arteries, 'pv' – pulmonary veins, 'ra' – right atrium, 'la' – left atrium),  $V_{uc}$  is the volume of the compartment  $c$  at zero pressure (called unstressed volume), therefore:

$$p_c = \frac{V_c - V_{uc}}{C_c}. \quad (12)$$

Additionally it is assumed that the blood volume in systemic veins is equal to the difference between the total blood volume ( $V$ ) and the blood volume in other five compartments, thus:

$$V_{sv} = V - V_{sa} - V_{pa} - V_{pv} - V_{ra} - V_{la}, \quad (13)$$

$$V_{usv} = V_u - V_{usa} - V_{ups} - V_{upv} - V_{ura} - V_{ula}. \quad (14)$$

Therefore, using Eq. (11):

$$p_{sv} = \frac{V_{sv} - V_{usv}}{V_{sv}} = \frac{1}{C_{sv}} \times (V - V_u - C_{sa} p_{sa} - C_{pa} p_{pa} - C_{pv} p_{pv} - C_{ra} p_{ra} - C_{la} p_{la}). \quad (15)$$

Cardiac output in the left and right ventricles –  $q_l$ ,  $q_r$  (blood volume pumped by heart per a unit of time) is equal to the product of heart frequency ( $f$ ) and stroke volume,  $S$  (blood volume ejected from the heart during systole). Frank-Starling mechanisms states that the more the heart is filled during diastole, the more will be the quantity of blood pumped into the aorta [8]. In other words, increasing left (or right) ventricular pressure increases stroke volume. According to this mechanism, the stroke volume depends on the diastolic volume, and, therefore, on the pressure in the left (or right) atrium ( $p_{la}$  or  $p_{ra}$ ) [2]:

$$q_s = S_s f = \frac{S_s}{T} = \frac{k_s(p_c - p_{c0})}{a_s} / T, \quad (16)$$

where  $s = r$  (right ventricle) or  $l$  (left ventricle),  $p_c - p_{c0}$  (for  $s = 'l'$ ) or  $p_{ra}$  (for  $s = 'r'$ ),  $k_s$  ( $k_l$  or  $k_r$ ),  $p_{la0}$  and  $p_{ra0}$  describe the cardiac effectiveness,  $a_s$  ( $a_l$  or  $a_r$ ) is the function describing the effect of the decrease of the stroke volume in response to an excessive increase of the arterial pressure or pressure in the pulmonary arteries:

$$a_s = \begin{cases} 1 & p_k \leq p_{kn} \\ \sqrt{\frac{p_k}{p_{kn}}} & p_k \geq p_{kn} \end{cases} \quad (17)$$

where  $p_k - p_{sa}$  (for  $s = 'l'$ ) or  $p_{pa}$  (for  $s = 'r'$ ),  $p_{san}$  and  $ppan$  describe the boundary conditions for this effect.

Experimental studies have demonstrated the existence of a biphasic response to blood volume losses [2]. During the first phase, the blood pressure is maintained on the same level by changes of values of parameters of the cardiovascular system: the systemic resistance, heart period and systemic venous

unstressed volume. This compensation depends upon the action of two groups of baroreceptors: the arterial and the cardiopulmonary receptors. If the systemic arteries pressure or the right atrium pressure decrease or increase above the normal value, then the signal is produced to modify the systemic resistance, heart period and systemic venous unstressed volume. When the blood volume falls below a critical level (the left atrial pressure falls below a specific threshold), the second response phase begins. This phase is triggered by a signal with very rapid dynamics. The signal is sent to the central nervous system, causing the inhibition of the control mechanism. The control mechanisms are described using equations and values of parameters as in the reference [2].

**2.3. Glucose-insulin interactions.** Glucose-insulin system modelling is of special importance because kidney failure is a frequent late complication of diabetes. In Poland up to 20%, in Japan near 40% while in USA about 50% of all new patients on renal replacement therapies are diabetics [9].

The hormones which are the most important in glucose regulation are insulin and glucagon. When glucose concentration in the extracellular fluid increases (i.e. during eating) the rising concentration causes the pancreas to secrete increased quantities of insulin. The insulin, in turn, causes increased transport of glucose across the cell membranes to the interior of the cells in most parts of the body. The glucose is then used for energy. This returns the extracellular glucose concentration back toward the normal value. Changes in blood glucose concentration have exactly the opposite effect on glucagon secretion as on insulin secretion. That means, a decrease in blood glucose increases glucagon secretion. The most dramatic effect of glucagon is its ability to cause glycogenolysis in the liver, which in turn increases the blood glucose concentration within minutes.

To describe glucose-insulin interactions model by Stolwijk-Hardy (1974) was used in the "virtual patient" [5,10]. In spite of being developed more than 30 years ago, the model is still referenced (e.g. in 2000 in [5]) and considered as suitable to describe regulation of glucose blood concentration. In this model, as well as in most of simple models describing glucose regulation, glucagon was not taken into account (Fig. 6).

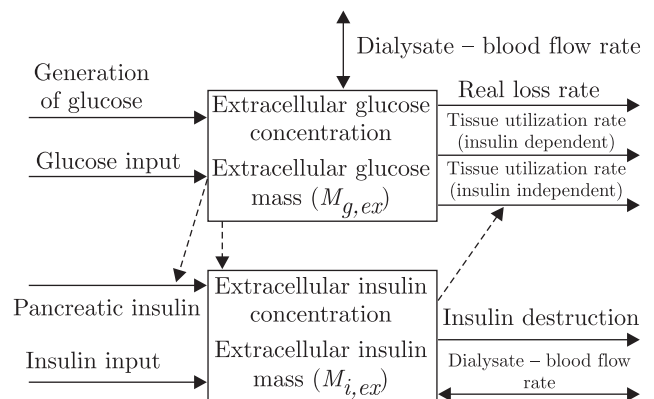

Fig. 6. Scheme of the model describing glucose-insulin interactions

## Development of “virtual patient” model for simulation of solute and fluid transport during dialysis

In the model it is assumed that the mass of glucose in extracellular fluid is influenced by glucose generation ( $G_{g,ex}$  – glucose generation rate), external source of glucose ( $S_g$ ), renal loss  $R_g$  – renal loss rate, if residual renal function exists) and two types of glucose utilization: insulin dependent ( $U_d$ ) and insulin independent ( $U_{id}$ ), also impact of dialysis is taken into account  $J_{g,d}$  – glucose flow rate from or to dialysate). Thus [5,10]:

$$\frac{dM_{g,ex}}{dt} = G_{g,ex} + S_g - R_g - U_d - U_{id} - J_{g,d}. \quad (18)$$

In the model it is assumed that when glucose concentration ( $C_{g,ex}$ ) decreases below a certain threshold ( $\theta$ ), glucose is excreted by the kidneys ( $R_g$ ) at a rate proportional to the gradient between  $C_{g,ex}$  and  $\theta$  (if residual renal function exists). Therefore [5]:

$$R_g = \begin{cases} \mu(C_{g,ex} - \theta) & C_{g,ex} > \theta \\ 0 & C_{g,ex} \leq \theta \end{cases}. \quad (19)$$

Glucose leaves the blood and enters to most cells by diffusion. In cases of insulin independent utilization, the rate of glucose utilization depends only on the extracellular-to-intracellular concentration gradient. The intracellular concentration is assumed equal to 0 (because in the cell glucose is changed to glycogen). Thus [5]:

$$U_{id} = \lambda C_{g,ex}. \quad (20)$$

In certain types of cells, such as those in muscle, insulin helps to stimulate diffusion process. Therefore, the rate at which glucose is taken up by these cells is proportional to  $C_{g,ex}$  as well as to the blood insulin concentration  $C_{i,ex}$  [5]:

$$U_d = \gamma C_{g,ex} C_{i,ex}. \quad (21)$$

It is also assumed, that glucose generation rate ( $G_{g,ex}$ ) can be constant (or depends on plasma glucose concentration).

A similar mass balance equation is established for blood insulin. It is assumed that insulin mass changes due to insulin generation ( $G_{i,ex}$  – insulin generation rate), insulin destruction ( $DR_i$  – insulin destruction rate), external source of glucose ( $S_i$ ) and transport during dialysis ( $J_{i,d}$  – insulin flow rate to dialysate). Therefore [5]:

$$\frac{dM_{i,ex}}{dt} = G_{i,ex} + S_i - DR - J_{i,d}. \quad (22)$$

Insulin is produced by the pancreas at a rate dependent on the plasma glucose level. However, if concentration of glucose falls below a certain threshold ( $\varphi$ ), insulin production is interrupted. Thus [5]:

$$G_{i,ex} = \begin{cases} 0 & C_{g,ex} \leq \varphi \\ \beta(C_{g,ex} - \varphi) & C_{g,ex} > \varphi \end{cases}. \quad (23)$$

Additionally, insulin is destroyed through a reaction involving the insulinase enzyme, at a rate proportional to its concentration in blood [5]:

$$DR_i = \alpha C_{i,ex}. \quad (24)$$

**2.4. Dialysis.** In the model, several variables were introduced for the description of the influence of the renal replacement therapy on fluids and solutes in the body:  $Q$  – described fluid ultrafiltration flow rate across the hemodialyzer membrane (during hemodialysis) or across peritoneal tissue to dialysate (during peritoneal dialysis),  $J_{s,t}$  – described solute flow rate during treatment (in the hemodialyzer when  $t = 'hd'$  or peritoneal dialysis when  $t = 'pd'$ ).

**Hemodialysis.** In hemodialysis, excess of fluid is removed due to transmembrane pressure gradient (which causes an ultrafiltration flow across the membrane), whereas solute removal is achieved by diffusion (driven by the difference of solute concentration between dialysate and blood) and convection (due to ultrafiltration). Transmembrane pressure gradient is set in automatic ultrafiltration control system (artificial kidney). Hemodialyzer efficiency of solute removal is described by dialysance defined as the amount of solute removed from the blood per unit time, divided by the solute concentration difference between blood and dialysate at the dialyzer inlet [11]:

$$D_s = \frac{Q_{Bi}C_{Bi} - Q_{Bo}C_{Bo}}{C_{Bi} - C_{Di}} \quad (25)$$

where:  $Q_{Bi}$ ,  $Q_{Bo}$  – blood flows at the dialyzer inlet and outlet,  $C_{Bi}$ ,  $C_{Bo}$  – substance concentrations in blood at the dialyzer inlet and outlet,  $C_{Di}$  – substance concentration in dialysate at the dialyzer inlet. When the solute concentration in dialysate is equal to 0 (e.g. urea), dialysance is called clearance.

Ultrafiltration from blood to dialysate increases solute flow in the following way [6,12]:

$$D_s = D_{0,s} + Tr Q_f \frac{C_{s,ex}}{C_{s,ex} - C_{s,d}}, \quad (26)$$

where  $D_s$  – dialysance of solute  $s$  in the dialyzer (or clearance when  $C_{s,d} = 0$ ),  $D_{0,s}$  – pure diffusive dialysance (clearance) when the ultrafiltration flow rate is equal to 0,  $Tr$  – transmittance coefficient,  $Q_f$  – ultrafiltration flow rate,  $C_{s,ex}$  – concentration of solute  $s$  in blood,  $C_{s,d}$  – concentration of solute  $s$  in dialysate.

Diffusive dialysance (clearance) is usually provided by dialyzer manufacturer or can be determined experimentally and calculated for particular solute using Eq. (25) with  $Q_{Bi} = Q_{Bo} = Q_B$  ( $Q_f = 0$ ).

A simple linear description of  $Tr$  can be obtained assuming that each kind of transport (diffusive and convective) occurs separately: first pure diffusion and then pure convection [6,12]:

$$Tr = S \left( 1 - \frac{D_{0,s}}{Q_B} \right), \quad (27)$$

where  $S$  – sieving coefficient,  $Q_B$  – blood flow rate.

Sieving coefficient describes the membrane property for a particular solute (sieving coefficient is between 0 and 1): sieving coefficient equal to 0 means that the membrane is impermeable for the solute, while value of 1 means that membrane is absolutely permeable for the substance [11].

In Eq. (8), variable  $J_{s,hd}$  described the solute's flow rate in the dialyzer. Hence, from Eqs. (26) and (27) (assuming  $S = 1$

for all small solutes):

$$J_{s,hd} = D_s (C_{s,ex} - C_{s,d}) = \left( D_{0,s} \left( 1 - \frac{Q_f}{Q_B} \right) + Q_f \right) c_{s,ex} - D_{0,s} c_{s,d}, \quad (28)$$

In “virtual patient” model fluid flow rate caused by hemodialysis ( $Q$  in Eq. (1)) is simply described as fluid ultrafiltration flow rate, thus:

$$Q = Q_f. \quad (29)$$

**Peritoneal dialysis.** Nowadays, peritoneal dialysis, in dependence on country, comprises of 5% to 45% of the population of renal failure patients [11]. Physiological mechanisms of water and solute transport across the peritoneum are rather complex. Recently, peritoneal microcirculation and transport across the peritoneum is an important subject of various studies [13,14]. In this article the new theoretical model, where interstitium was included as a separate compartment, is proposed. The model is partly based on the three-pore model [4] extended by the description of fluid uptake by absorption due to the Starling forces (i.e. forces that cause the exchange of fluids between the intravascular and interstitial space [8]) in addition to the absorption by lymphatics.

The three-pore model of peritoneal transport has been used for description of the transport of fluid and solutes between interstitium and blood. It is assumed, that capillaries in the peritoneal tissue are heteroporous with three sizes of pores: large pores (radius 250 Å), small pores (radius 43 Å), and ultrasmall pores (radius 2 Å). A large number of small pores causes that membrane is permeable to most small solutes, whereas low number of large pores allows the transport of macromolecules (proteins) from blood to peritoneal cavity. Ultrasmall pores (aquaporins) reject solute transport, and play an important role in osmotic water transport.

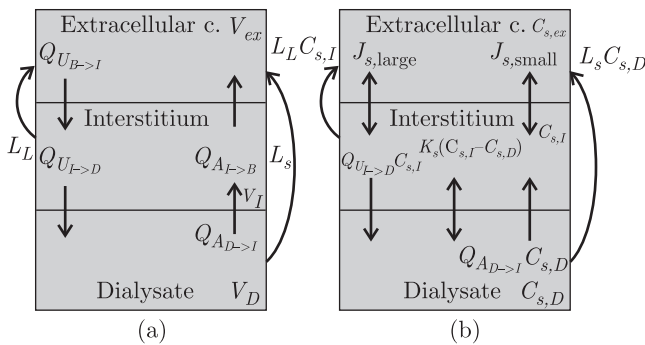

Fig. 7. Scheme of the compartmental model describing transport of fluids (a) and solutes (b) between dialysate and blood during peritoneal dialysis;  $V_c$  – volume of fluid in compartment  $c$  ( $c = 'ex'$  – extracellular fluid,  $'I'$  – peritoneal interstitium,  $'D'$  – dialysate),  $Q_A$  – fluid absorption rate ( $I \rightarrow B$  – from interstitium to blood,  $D \rightarrow I$  – from dialysate to interstitium),  $Q_U$  – fluid ultrafiltration rate ( $B \rightarrow I$  – from blood to interstitium,  $I \rightarrow D$  – from interstitium to dialysate),  $L_s$  and  $L_L$  – systemic and local lymphatic flow rate,  $C_{s,c}$  – concentration of solute  $s$  in compartment  $c$ ,  $K_s$  – permeability surface area coefficient for solute  $s$ ,  $J_{s,p}$  – solute  $s$  flow through pores  $p$  ( $p = 'small'$  or  $'large'$ )

The basic assumption of this model is the following idea: when the solute or fluid leaves the peritoneal cavity, it must first enter the interstitium and then be sieved by the capillary wall (Figs. 7a,b).

In accordance with a scheme in Fig. 7a, the dialysate volume depends basically on the following factors: ultrafiltration flow rate from interstitium to dialysate ( $Q_{U_{I \rightarrow D}}$ ), fluid absorption rate due to hydrostatic pressure difference between dialysate and interstitial fluid ( $Q_{A_{D \rightarrow I}}$ ) and systemic lymphatic flow rate ( $L_s$ ). Therefore:

$$\frac{dV_D}{dt} = Q_{U_{I \rightarrow D}} - Q_{A_{D \rightarrow I}} - L_s. \quad (30)$$

Change of interstitial volume results from ultrafiltration flow rate from interstitium to dialysate ( $Q_{U_{I \rightarrow D}}$ ), ultrafiltration flow rate from blood to interstitium ( $Q_{U_{B \rightarrow I}}$ ), fluid absorption rate due to hydrostatic pressure difference from dialysate to interstitium ( $Q_{A_{D \rightarrow I}}$ ), fluid absorption rate due to Starling forces from interstitium to blood ( $Q_{A_{I \rightarrow B}}$ ) and local lymphatic flow rate ( $L_L$ ). Thus:

$$\frac{dV_I}{dt} = Q_{A_{D \rightarrow I}} - Q_{U_{I \rightarrow D}} + Q_{U_{B \rightarrow I}} - Q_{A_{I \rightarrow B}} - L_L. \quad (31)$$

Mesothelial barrier between peritoneal cavity and interstitium is very permeable to substances [14,15], therefore it is assumed that ultrafiltration flow rate from blood to interstitium ( $Q_{U_{B \rightarrow I}}$ ) and ultrafiltration flow rate from interstitium to dialysate ( $Q_{U_{I \rightarrow D}}$ ) are equal.  $Q_{U_{B \rightarrow I}}$  depends on the hydrostatic pressure difference and crystalloid osmotic pressure difference between blood and interstitium. Therefore:

$$Q_{U_{I \rightarrow D}} = Q_{U_{B \rightarrow I}} = Q_{U_s} + Q_{U_l} + Q_{U_u} \quad (32)$$

where  $Q_{U_p}$  is the ultrafiltration flow rate through the pore  $p$  ( $p = 's'$  – small,  $'l'$  – large,  $'u'$  – ultrasmall) and:

$$Q_{U_p} = \alpha_p L_p S \left( \Delta P - \sum_{s \neq p} \sigma_{s,p} \Delta \pi_s \right), \quad (33)$$

where  $\alpha_p$  – the “fraction of  $L_p S$ ” accounted for by the specific set of pore ( $\alpha_s + \alpha_l + \alpha_u = 1$ ),  $L_p S$  – ultrafiltration coefficient,  $\Delta P$  – hydrostatic pressure gradient between blood and interstitium ( $\Delta P = P_B - P_I$ ),  $P_C$  – hydrostatic pressure in compartment  $C$ :  $'B'$  – blood,  $'I'$  – interstitium,  $'D'$  – dialysate),  $\sigma_{s,p}$  – solute  $s$  osmotic reflection coefficient for pore  $p$ ,  $\Delta \pi_s$  – osmotic pressure gradient between blood and interstitium for solute  $s$  ( $\Delta \pi_s = RT(C_{s,B} - C_{s,I})$ ),  $RT$  – the product of gas constant and the absolute temperature,  $C_{s,C}$  – concentration of solute  $s$  in compartment  $C$  (assuming  $C_{s,B} = C_{s,ex}$ ).

Starling’s hypothesis states that the fluid movement across the blood capillaries walls depends on the balance of the hydrostatic pressure gradient and the oncotic pressure gradient (oncotic pressure is a pressure due to the presence of large protein molecules) [8]. As mesothelial barrier between peritoneal cavity and interstitium is very permeable [14,15], the concentrations of the solutes (e.g. protein) in dialysate and interstitium are almost equal. Thus only hydrostatic pressure difference is important in fluid absorption from dialysate to interstitium:

$$Q_{A_{D \rightarrow I}} = L_p S_1 (P_D - P_I). \quad (34)$$

Development of “virtual patient” model for simulation of solute and fluid transport during dialysis

Whereas fluid absorption from interstitium to blood is described using the following equation:

$$Q_{A_{I \rightarrow B}} = Q_{A_s} + Q_{A_l} + Q_{A_u}, \quad (35)$$

where  $L_p S_1$  – ultrafiltration coefficient,  $Q_{A_p}$  – fluid absorption through the pore  $p$ , and:

$$Q_{A_p} = -\alpha_p L_p S (\Delta P - \sigma_{Pr,p} \Delta \pi_{Pr}) \quad (36)$$

where Pr – protein. In “virtual patient” model fluid flow rate caused by peritoneal dialysis (Q in Eq. (1)) is described as:

$$Q = Q_{U_{B \rightarrow I}} - Q_{A_{I \rightarrow B}} - L_s - L_L. \quad (37)$$

The solute flow between dialysate and interstitium is caused by diffusion (driven by the difference of solute’s concentrations in dialysate and interstitium), convection (due to ultrafiltration), fluid absorption due to Starling forces and fluid absorption due to lymphatics (Fig. 7 b). Thus, the mass balance equation for solute in dialysate can be written as follows:

$$\frac{dM_{s,D}}{dt} = K_s (C_{s,I} - C_{s,D}) - Q_{A_{D \rightarrow I}} \times C_{s,D} + S_s Q_{U_{I \rightarrow D}} C_{s,I} - L_s C_{s,D}, \quad (38)$$

where:  $M_{s,C}$  – mass of solute  $s$  in compartment  $C$ ,  $K_s$  – permeability surface area coefficient for solute  $s$ ,  $S_s$  – sieving coefficient for solute  $s$  (as membrane between peritoneal cavity and interstitium is highly permeable, high value of  $K_s$  and  $S_s = 1$  were assumed for all solutes).

Change of the solute mass in the interstitium can be caused by solute flow between dialysate and interstitium and solute flow between interstitium and blood. Thus:

$$\frac{dM_{s,I}}{dt} = Q_{A_{D \rightarrow I}} C_{s,D} - S_s Q_{U_{I \rightarrow D}} \times C_{s,I} - K_s (C_{s,I} - C_{s,D}) - L_L C_{s,I} + J_{S_{s,s}} + J_{S_{s,l}}, \quad (39)$$

where:  $J_{S_{s,p}}$  – solute  $s$  flow through pores  $p$  ( $p$ : ‘s’ – small or ‘l’ – large) according to three-pore model [4] and:

$$J_{S_{s,p}} = J_{V_p} (1 - \sigma_{s,p}) \frac{C_{s,B} - C_{s,I} e^{-Pe_{s,p}}}{1 - e^{-Pe_{s,p}}}, \quad (40)$$

where  $Pe_{s,p}$  – Peclet number given by  $Pe_{s,p} = J_{V_p} (1 - \sigma_{s,p}) / PS_{s,p}$  ( $PS_{s,p}$  is a permeability surface area for pore  $p$  and solute  $s$ ) and  $J_{V_p}$  – the fluid flow through the pores yielded by, [4]:

$$J_{V_p} = Q_{U_p} - Q_{A_p}, \quad (41)$$

where  $Q_{U_p}$  is given by (33) and  $Q_{A_p}$  is given by (36). In Eq. (6), variable  $J_{s,pd}$  describes the solute’s flow rate due to peritoneal dialysis. Therefore:

$$J_{s,pd} = J_{S_{s,s}} + J_{S_{s,l}} - L_L C_{s,I} - L_s C_{s,D}. \quad (42)$$

### 3. Materials and methods

The presented “virtual patient” model is described as a set of ordinary differential equations and algebraic equations with various types of nonlinearities: square root, exponential function, division by variable and rise to the power.

This model has been implemented in computer using program Matlab. The system of ordinary differential equation was

solved using function ode45. Function ode45 is based on an explicit Runge-Kutta (4,5) formula.

To evaluate the model, fluid transport was studied in several groups of patients in various hospitals. A single six hour dwell study using standard glucose 3.86% dialysis fluid in 20 patients on continuous ambulatory peritoneal dialysis were carried on in Divisions of Baxter Novum and Renal Medicine, Department of Clinical Sciences, Karolinska University Hospital Huddinge, Stockholm, Sweden (Prof. B. Lindholm). Also, model was verified using data from the Department of Internal Medicine University Hospital Maastricht, the Netherlands (Prof. J. Kooman). These data (concerning 11 patients undergone hemodialysis) were from pilot study in which there was investigated the hemodynamic effects of different dialysis procedures during hemodialysis, mainly differing in their sodium handling. Additionally, the data from Department of Nephrology, Louis Pasteur District Hospital, Cherbourg, France (dr P. Freida) were used. During these investigations various dialysate compositions were tested and compared in 7 patients undergone a single fifteen hours peritoneal dialysis: dialysate with glucose 3.86%, dialysate with icodextrin 7.5%, and dialysate with mixture of glucose 2.73% and icodextrin 6.8%.

### 4. Results

The “virtual patient” model was applied to simulate the behaviour of pressures, fluids and solutes during hemodialysis and peritoneal dialysis. Parameters describing typical patient were taken from literature [1–4,8,14,16] and used in simulations.

Peritoneal dialysis patient treated with 3.86% glucose dialysis solution is exposed to the high glucose concentrations, which can lead to metabolic problem such as hyperglycemia, hyperinsulinemia or obesity, also glycation of peritoneal membrane proteins may be responsible for membrane failure. To avoid this situation a combination fluid with a small glucose concentration and icodextrin was evaluated [17]. Therefore, simulations were carried out to predict the behavior of the dialysate volume and the concentration of the dialysate glucose during the peritoneal dialysis, using various dialysis fluid compositions (3.86% glucose, 7.5% icodextrin and 2.73% glucose/6.8% icodextrin, Figs. 8 and 9). It turned out that the combination fluid (Fig. 9) removes larger volumes of water than 3.86% glucose fluid (Fig. 8).

Fluid and solute transport was also studied in a single six hour dwell study using standard glucose 3.86% dialysis fluid in 20 patients on continuous ambulatory peritoneal dialysis (data from Stockholm, Sweden). As shown in Fig. 10, there was a good agreement between simulations of the model and experimental data.

The model allows for differentiation of the nature of the fluid uptake: lymphatic absorption or absorption of the fluid due to Starling forces. In three-pore model [4] the fluid uptake is described inadequately by assuming that fluid absorption is by systemic lymphatics only. Physiological investigations show that a rate of fluid absorption via lymphatics is about 0.3

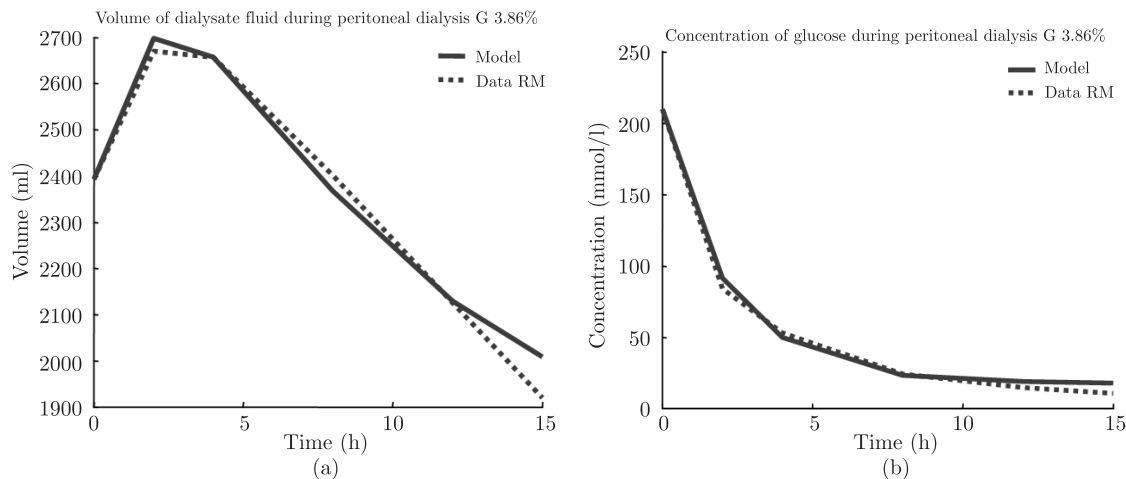

Fig. 8. Dialysate volume (a) and concentration of dialysate glucose (b) during peritoneal dialysis (data from Cherbourg, France) with glucose dialysis fluid; — model simulation, - - - experimental data

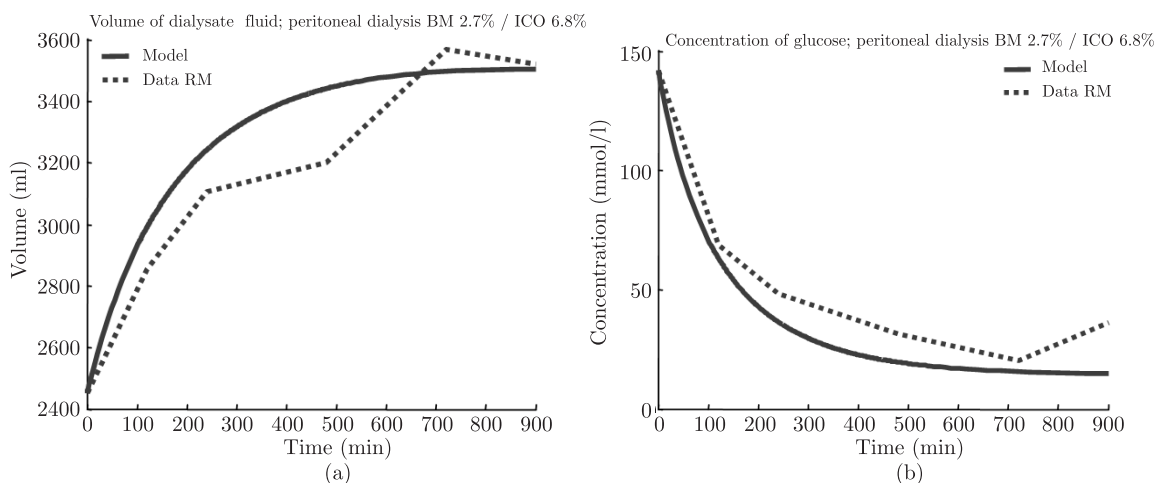

Fig. 9. Dialysate volume (a) and concentration of dialysate glucose (b) during peritoneal dialysis (data from Cherbourg, France) with bimodal solution with glucose 2.7% and icodextrin 6.8%; — model simulation, - - - experimental data

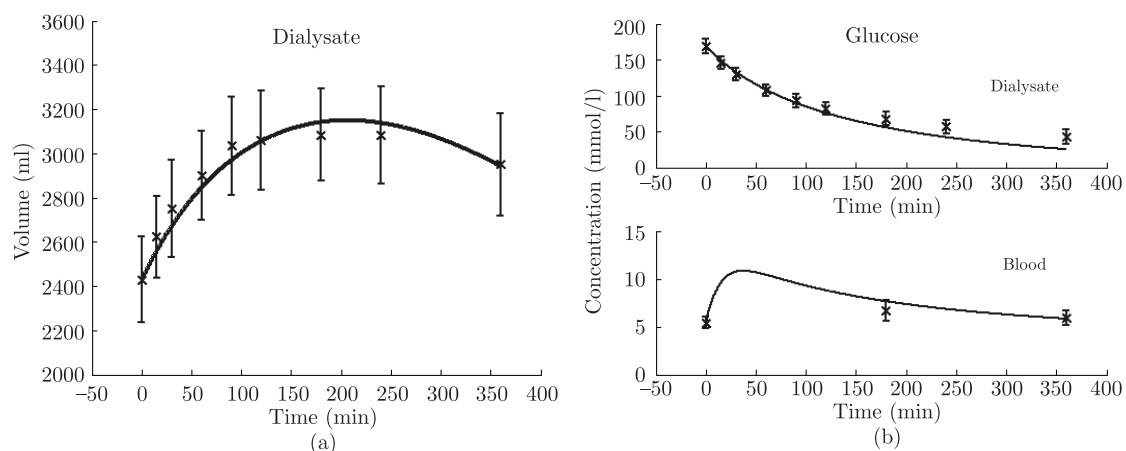

Fig. 10. Simulation of the dialysate volume (a) and glucose concentration (b) during peritoneal dialysis (data from Stockholm, Sweden): — simulation results, X – experimental data (mean value with standard deviation)



## Development of “virtual patient” model for simulation of solute and fluid transport during dialysis

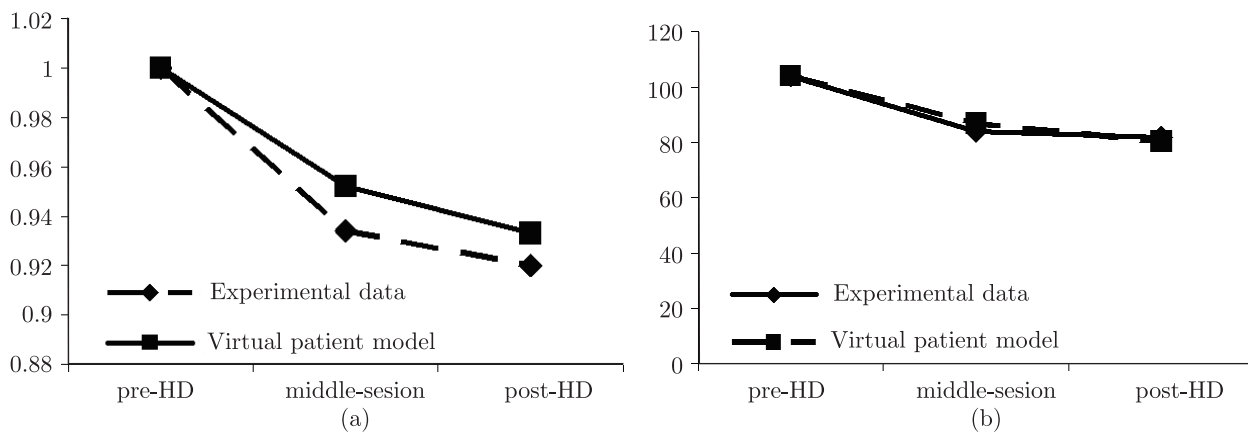

Fig. 11. Relative blood volume, (–) (a) and mean arterial pressure, (mmHg) (b) during standard hemodialysis (data from Maastricht, the Netherlands) ♦ experimental data, ■ simulation result

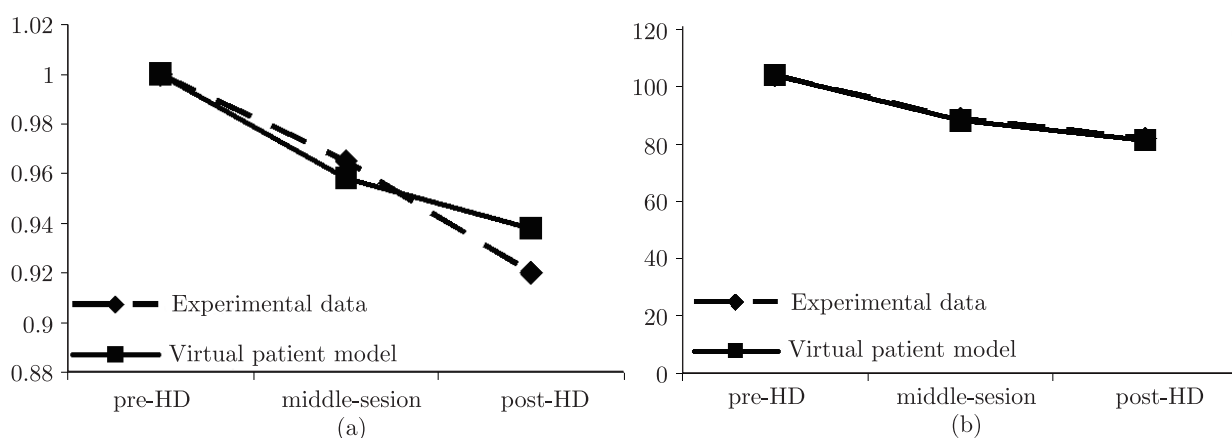

Fig. 12. Relative blood volume, (–) (a) and mean arterial pressure, (mmHg) (b) during hemodialysis with sodium profile (data from Maastricht, the Netherlands) ♦ experimental data, ■ simulation result

ml/min, [13,18]. However various studies with volume marker have shown that the fluid absorption rate is above 1 ml/min, [19–21]. This also is confirmed by the simulations of the model.

Usually, hemodialysis sessions are carried out in the cycle with the intervals between the sessions lasting 2–3 days. One session usually takes 4–5 hour (the relative risk of death is lowest at treatment times of 4.5 to 5 hours, [22]). Control of extracellular volume is one of the primary targets of dialysis therapy. Inadequate sodium and fluid removal by dialysis may result in extracellular volume overload, hypertension and increased cardiovascular morbidity and mortality. Virtual patient model could be used for simulation of various hemodialysis procedures.

In Figs. 11 and 12 two procedures were shown: standard dialysis (with sodium concentration 140 mmol/l) and dialysis with sodium profiling (with sodium concentration decrease from 148 mmol/l to 136 mmol/l). Figures 11 and 12 show the behaviour of the blood volume and mean arterial pressure during dialysis. Again, the model reproduced the clinical data rather correctly.

## 5. Conclusions

The presented “virtual patient” is a computer model of basic, short-term physiological phenomena. It is important for understanding the body’s response to hemodialysis and/or peritoneal dialysis.

The model was used for simulations of solutes concentrations and fluids volumes changes during the peritoneal dialysis with different dialysis solutions and during various procedures of hemodialysis.

The developed model seems to provide efficient description of the fluid and solute transport during dialysis treatments (hemodialysis or peritoneal dialysis). However, this model still requires verification and confirmation.

## REFERENCES

- [1] J.T. Daugirdas, P.G. Blake, and S. Todd, *Handbook of Dialysis*, Lippincot, Williams and Wilkins, 2001.
- [2] M. Ursino and M. Innocenti, “Modeling arterial hypotension during hemodialysis”, *Artif. Organs* 21(8), 873–890 (1997).
- [3] L. Coli, M. Ursino, A. De Pascalis, C. Brighenti, V. Dalmastrì, G. La Manna, E. Isola, G. Cianciolo, D. Patrono, P. Boni, and

- S. Stefoni, "Evaluation of intradialytic solute and fluid kinetics. Setting up a predictive mathematical model", *Blood Purif.* 18(1), 37–49 (2000).
- [4] B. Rippe, and L. Levin, "Computer simulations of ultrafiltration profiles for an icodextrin-based peritoneal fluid in CAPD", *Kidney Int.* 57(6), 2546–2556 (2000).
- [5] M.C.K. Khoo, *Physiological Control Systems; Analysis, Simulation, and Estimation*, New York, IEEE Press, 2000.
- [6] M. Gałach, A. Ciechanowska, S. Sabalinska, J. Waniewski, J. Wojcicki, and A. Weryński, "Impact of convective transport on dialyzer clearance", *J. Artif. Organs* 6(1), 42–48 (2003).
- [7] M. Gałach and A. Weryński, "Mathematical modeling of renal replacement therapies", *Biocybernetics and Biomedical Engineering* 24(4), 3–18 (2004).
- [8] A.C. Guyton, *Textbook of Medical Physiology*, W.B. Saunders Company, 1981.
- [9] W. Grzeszczak, "Diabetes mellitus – serious nephrological problem in XXI century", *Progresses of Medical Sciences* XIV(1–2), (2003), (in Polish).
- [10] V.B. Mountcastle, *Medical Physiology*, St. Louis, C.V. Mosby, 1974.
- [11] M. Darowski, T. Orłowski, A. Weryński, and J.M. Wójcicki, "Artificial organs", *Biocybernetics and Biomedical Engineering* 2000 3, 523 (2001), (in Polish).
- [12] A. Weryński, "Evaluation of the impact of ultrafiltration on dialyzer clearance", *Artif. Organs* 3(2), 140–142 (1979).
- [13] B. Rippe, B.I. Rosengren, and D. Venturoli, "The peritoneal microcirculation in peritoneal dialysis", *Microcirculation* 8(5), 303–320 (2001).
- [14] D. Venturoli and B. Rippe, "Transport asymmetry in peritoneal dialysis: application of a serial heteroporous peritoneal membrane model", *Am. J. Physiol. Renal Physiol.* 280(4), F599–606 (2001).
- [15] M.F. Flessner, "The transport barrier in intraperitoneal therapy", *Am. J. Physiol. Renal Physiol.* 288(3), F433–442 (2005).
- [16] D.G. Struijk, G.C. Koomen, R.T. Krediet, and L. Arisz, "Indirect measurement of lymphatic absorption in CAPD patients is not influenced by trapping", *Kidney Int.* 41(6), 1668–1675 (1992).
- [17] S.B. Jenkins and M.E. Wilkie, "An exploratory study of a novel peritoneal combination dialysate (1.36% glucose/7.5% icodextrin), demonstrating improved ultrafiltration compared to either component studied alone", *Perit. Dial. Int.* 23(5), 475–480 (2003).
- [18] J.T. Daugirdas, T.S. Ing, V.C. Gandhi, J.E. Hano, W.T. Chen, and L. Yuan, "Kinetics of peritoneal fluid absorption in patients with chronic renal failure", *J. Lab. Clin. Med.* 95(3), 351–361 (1980).
- [19] J. Waniewski, O. Heimburger, A. Weryński, and B. Lindholm, "Simple models for fluid transport during peritoneal dialysis", *Int. J. Artif. Organs* 19(8), 455–466 (1996).
- [20] M. Flessner, "Effective lymphatic absorption rate is not a useful or accurate term to use in the physiology of peritoneal dialysis", *Perit. Dial. Int.* 24(4), 313–316, discussion 316–317 (2004).
- [21] R.T. Krediet, "The effective lymphatic absorption rate is an accurate and useful concept in the physiology of peritoneal dialysis", *Perit. Dial. Int.* 24(4), 309–313, discussion 316–307 (2004).
- [22] I. Uhlenbush-Korwer, E. Bonnie-Schorn, A. Grassmann, and J. Vienken, *Understanding Membranes and Dialysers*, Lengerich: Pabst Science Publishers, 2004.